

New Profec Operation Manual

Function

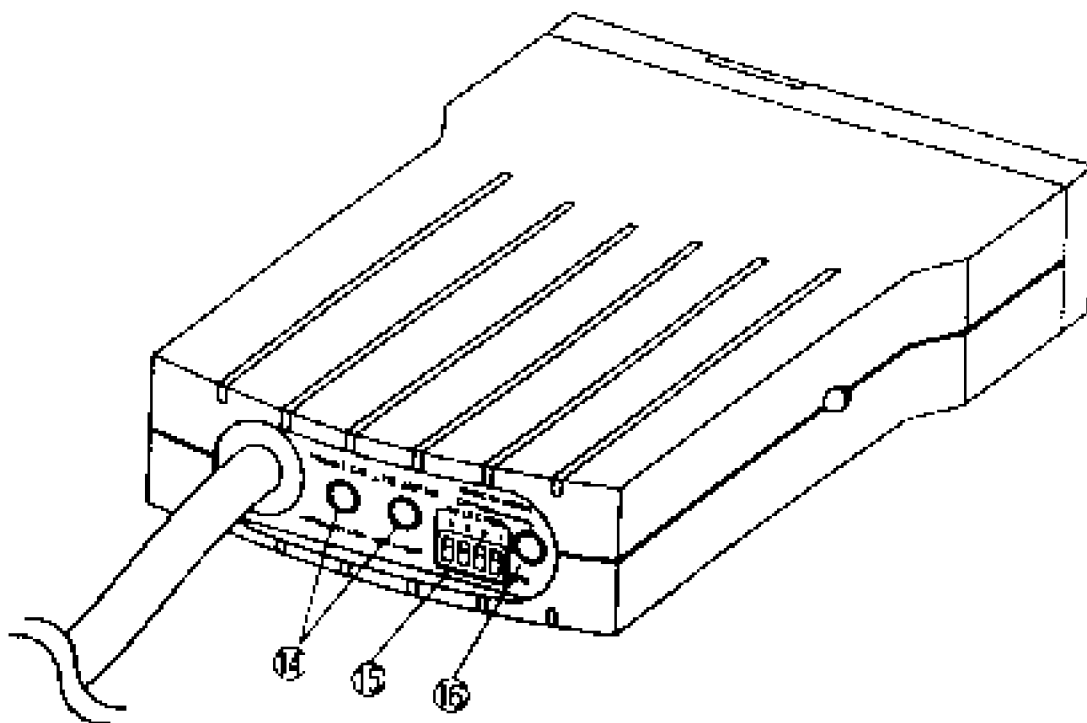
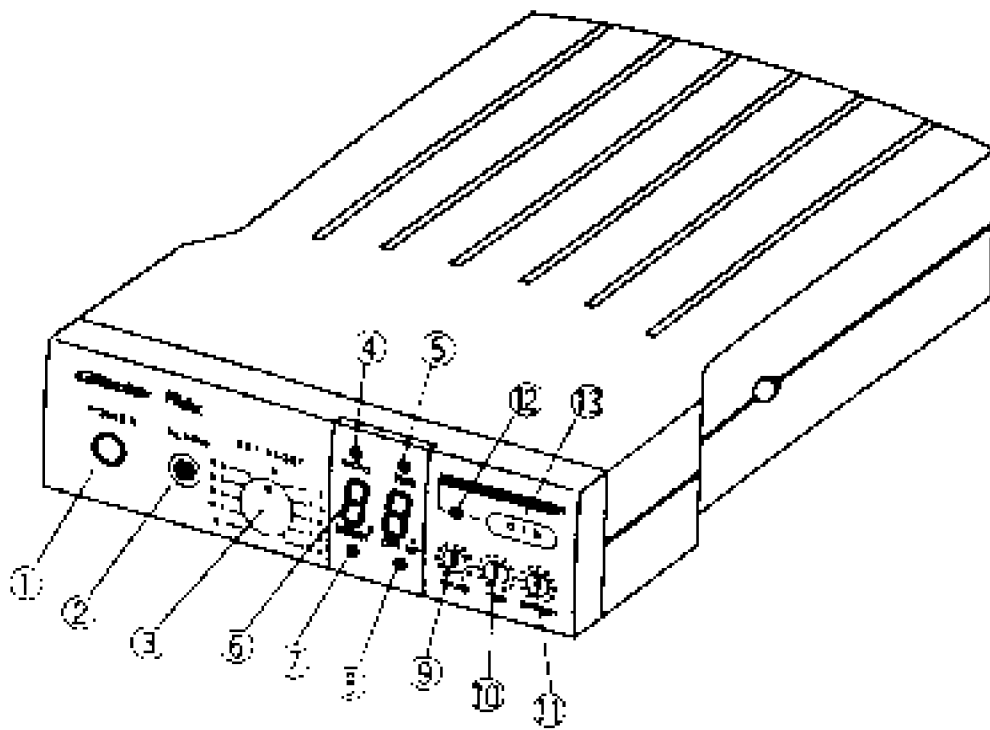

Function

1. **POWER SWITCH**
 - Turns the power "ON" and "OFF"
 - Enables check mode (hold 2 seconds)
 - Resets "P1" mode (hold over 2 seconds)
2. **ALARM LED**
 - Indicates when "Alarm" point has been reached
 - Indicates when in the "Alarm" setting mode
3. **SET BOOST DIAL**
 - Used to set desired "Set Boost" level (equal to or above base boost level)
4. **RATIO LED**
 - Indicates when in "Over-take Boost" HI mode
 - Indicates when in the OTB setting mode
5. **TIME LED**
 - Indicates when in "Over-take Boost" count down time
 - Indicates when in the count down setting mode
6. **DIGITAL DISPLAY**
 - Digital boost gauge
 - Displays: "Set boost" value, "OTB" value, "OTB" count-down time value and "Alarm" setting value
7. **BOOST LED**
 - Indicates when in "Set Boost" mode
8. **OFF-SET LED**
 - Indicates when in external wastegate "Off-set" mode
9. **OVER-TAKE BOOST LED**
 - Indicates when in "OTB" count down mode (flashing LED)
 - Indicates when in "HI Boost" mode (constant LED)
10. **OVER-TAKE BOOST SWITCH**
 - Activates "OTB" count down (press)
 - Activates or deactivates "HI Boost" mode (hold for 5 sec.)
 - When depressed with the "Power Switch" simultaneously, "Alarm" setting mode is activated
 - Used to toggle "Alarm" setting to desired "Alarm" level
11. **RATIO SWITCH**
 - Used to set desired "OTB" ("HI Boost") level (equal to or above base boost level)
12. **TIME SWITCH**
 - Used to set desired "OTB" count down time
13. **OFF-SET SWITCH**
 - Used to off set the point for external wastegates

Initial setting

Set the Selector on the back of the Profec according the vehicles application.

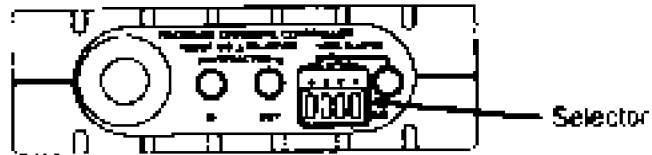

Selector 1	ON		Actuator type
	OFF		Wastegate type
Selector 2	ON		OFFSET : - 100 ~ + 100%
	OFF		OFFSET : - 50 ~ + 50%
Selector 3	ON		When over boosting occurred
	OFF		Norma
Selector 4	ON		When boost falls off
	OFF		Norma

- Make sure you that the selector switch is set at the appropriate setting. incorrect setting on the selector switch can cause engine damage

SET UP PROCEDURE

Learning Mode

This mode is to learn the features of Actuator type, External Wastegates, and the stability of the boost curve. GRaddy Profec has 2 learning functions:

PHASE 1 (P-1) Learns the stock base boost level.

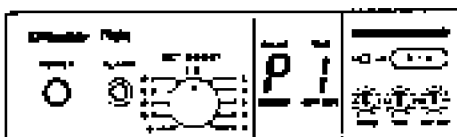

PHASE 2 (P-2) Learns the basic boost curve and the difference between the pressure in the wastegate and the pressure in the intake manifold.



This process must be done after the installation of Profec, and after any changes made to the characteristics of wastegate spring, or output power of the engine (I.E. Turbo size, Intercooler)

Basic Learning Procedure

- 1) Turn the power switch ON
- 2) The indicator will show "P-1"



- 3) Make a full throttle run in 3rd or 4th gear to get max boost (Base boost). When the max. boost is reached, LED will show maximum boost acquired during the run. Display will be flashing, reading out in BAR pressure.
- 4) Push the power switch twice to go to "P-2" mode. The indicator should show "P-2".



6) Make another full throttle run under same condition as you did in "P-1". When the indicator turns to an active boost gauge showing negative pressure when off throttle, "P-2" is completed. (If the indicator show "EE" make few more runs until you are successful. If you still get "EE", see Alternative Learning Procedure.)

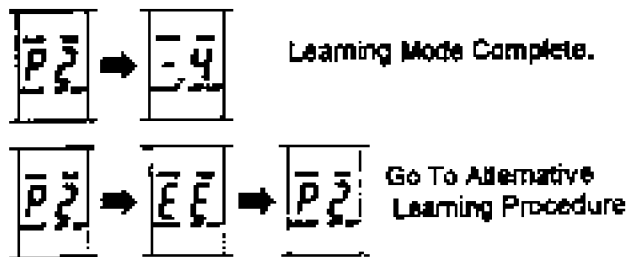

When programming the sequential turbo vehicle;

- 1 Make a full throttle run in 3rd gear to get boost, then right before the secondary turbo kicks in let off on the throttle.
- 2 Then, step on the throttle again to get the max boost

Alternative learning procedure

For the vehicle with an automatic transmission or a vehicle that have a difficult time learning "P-2", use this procedure to manually learn "P-2".

- 1) After going through "P-1" go to "P-2".
- 2) Depress the OTB switch for 5 sec



- 3) "P-2" will manually be programmed and the digital display will turn to an active boost gauge



Off Set

Compare the boost reading in the indicator and your aftermarket boost gauge. Adjust the Off Set accordingly by turning the Off Set dial using the supplied adjustment tool (clock wise to increase and counter clock wise to decrease the value (in 5% increments). If the indicator on the Profec reads 1.0 k/cm (14.2 psi) your boost gauge should read 1.0 k/cm (14.2 psi).



Set Boost Mode

This mode is used to set the desired Low Boost by turning the Set Boost dial.

How to set the Set Boost (Low Boost setting)

1. Lightly depress the Set Boost dial and make sure that it pops out.
2. Set to desired boost by turning the Set Boost dial
3. Once the dial has been left alone for 2 seconds, the Profec will beep signaling the entry has been accepted
4. Press the volume back in lightly
5. Make a series of full throttle runs, and the LED read out should show same boost reading as the Set Boost setting

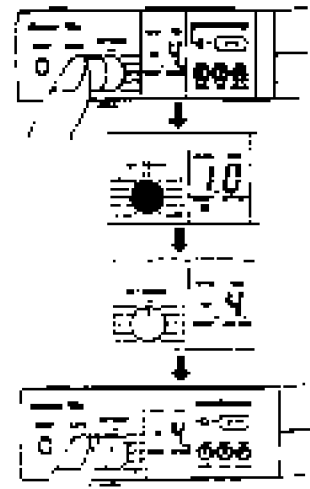

IMPORTANT

- If the Set Boost is set below the stock boost, the Profec will boost to the stock base pressure.
- Profec does not allow you to set the boost pressure below the stock base boost pressure.
- If over boost occurs see Trouble Shooting.
- Over boost is when boost attained during full throttle is higher then set boost setting

CAUTION

When increasing the boost Pressure, be careful not to increase over what your engine is capable of. Make sure that your Set Boost setting is a safe boost level for your engine. Over boosting may cause engine damage. GReddy Performance will Not be responsible for wrongful usage of this product.

O.T.B MODE (Over Take Boost) & HIGH BOOST MODE

O.T.B. Mode

This mode is used to boost above the Set Boost at a set Ratio above set boost setting during O.T.B. Operation Time.

How to set the O.T.B. Mode & High Boost Mode

1. Set the desired Set Boost
(See page 4 Set Boost Mode)
2. Set the O.T.B. or High Boost setting by adjusting the Ratio dial to desired O.T.B. or High Boost setting. The LED above the 'RATIO' in the indicator will light up and the O.T.B. or High Boost setting will be displayed.
(Setting limit: 0 - +50 % above the Set Boost)
3. Once the dial had been left alone for two seconds, the Profec will beep signaling the entry has been accepted.
4. Set the O.T.B. Operation Time by adjusting the TIME dial to desired O.T.B. Operation Time. The LED above the 'TIME' in the indicator will light up and the O.T.B. Operation Time will be displayed.
(Setting Limit: 0 - 30 sec.)

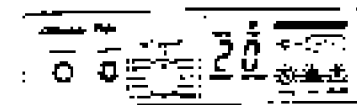
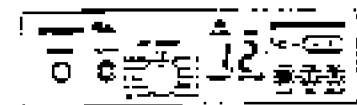
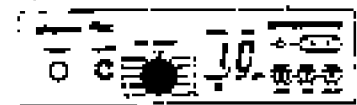

How To Use O.T.B. Mode

1. Push the O.T.B. switch once
As soon as you push the O.T.B. switch, the count down will start and the Profec will be in the O.T.B. Mode.
(do not press down on the O.T.B. switch over 2 sec. You will go in to High Boost Mode.)
2. At the end the count down, it will return to Set Boost Mode (Low Boost)

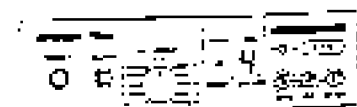
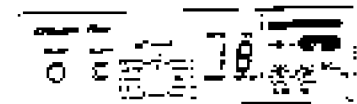

IMPORTANT

- To switch back to Set Boost Mode during the count down, simply push the O.T.B. switch once again.
- Do not adjust the Ratio or Time dial during O.T.B. Mode.
- If over boost occurs see Trouble Shooting
- Since the High Boost is determined by the Set Boost setting plus the Ratio dial setting, when the Set Boost setting is changed, make sure to change the Ratio setting to avoid any over boosting problem.

High Boost Mode

This Mode is used to boost above the Set Boost (Low Boost) setting at the set Ratio above set boost setting.

How To Use The High Boost Mode

1. Push the O.T.B. switch for over 2 seconds. The LED light next to the O.T.B. switch will light up, and the Profec will be in the High Boost Mode.
2. Push the O.T.B. switch once again to go back to Set Boost (Low Boost) Mode

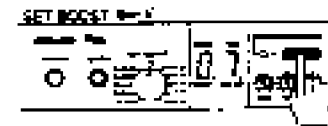

IMPORTANT

- Do not adjust the Ratio dial during the High Boost Mode.
- If over boost occurs see Trouble Shooting.
- Since the High Boost is determined by the Set Boost setting plus the Ratio dial setting, when the Set Boost setting is changed, make sure to change the Ratio setting to avoid any over boosting problem.

Warning Alarm

This function notifies the driver with an Alarm L.E.D. and Alarm Sound when the boost pressure exceeds the set Warning point. If this condition continues for more than a second, as a safety function, the boost pressure will return to the stock base boost level.

How To Set The Warning Alarm

1. Press the Power and O.T.B. switch simultaneously. Alarm L.E.D. will illuminate and the Warning setting will be displayed.
2. Press O.T.B. switch within a second, to toggle to desired the Warning point setting.
3. Once the switch has been left alone for 2 seconds, the Profec will beep signaling the entry has been accepted.



Warning Alarm Function

When Boost Pressure Exceeds the Warning Alarm Point for Over a Second;

- * Returns to stock base boost pressure until the boost pressure falls below the warning point.
- * Alarm sound will beep as long as the boost pressure is over the warning setting.
- * Alarm L.E.D. will be illuminated until it is cleared by pressing the Power switch

When Boost Pressure Exceeds the Warning Alarm Point For Less Than a Second;

- * Alarm sound will beep as long as the boost pressure is over the warning setting.
- * Alarm L.E.D. will be illuminated as long as the boost pressure is over the setting

Security Lock Mode

This mode is used to lock the Profec settings so that it can not be tampered with. This will prevent any problems or damage to the engine when the setting is accidentally changed.

How to Lock

1. Press the Power and O.T.B. switch simultaneously for 5 sec. For a second it will go in to Warning Mode, but continue pressing until "Lc" displays
2. Once "Lc" is displayed, the Profec is in Lock Mode, and the display will return to boost gauge mode.

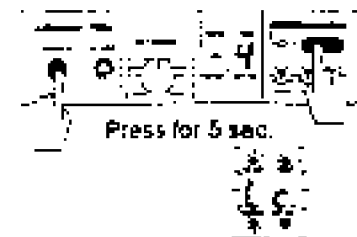

How to Unlock

1. Press the Power and O.T.B. switch simultaneously for 5 sec. For a second it will display "Lc", but continue pressing until "Un" displays.
2. Once "Un" is displayed, the Profec is in Unlocked
3. If the setting has been altered while in Lock Mode, "CH" will appear with altered volume L.E.D. lit and a beep.
4. Turn back the altered volume back to the original setting.
5. When the original setting is achieved, it will beep to confirm.
6. Repeat the steps 4, and 5 until all the altered L.E.D. is cleared.

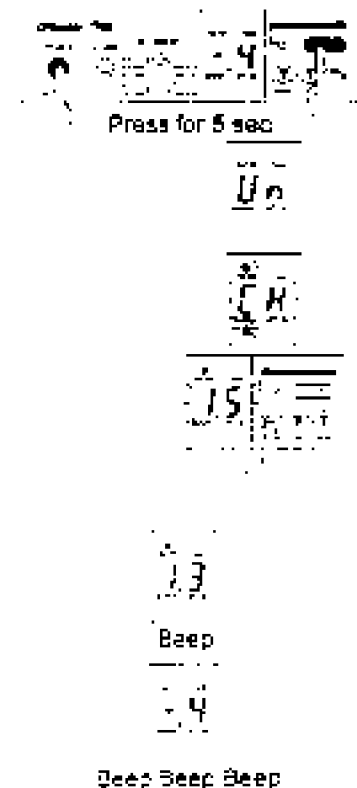

How To Confirm Settings

To check each setting points such as the set boost and O.T.B. boost settings.

Checking Method

1. Press the Power switch for only 2 seconds, no longer. The Profec Will beep
2. The Profec will start the Check Program and start showing the following in the indicator in the following order;



- (1) Display the Wastegate Type setting

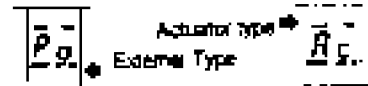

- (2) Display the SET BOOST setting



- (3) Display the O.T.B. setting



- (4) Display the O.T.B. Operating Time



- (5) Display the Off Set Adjusting Point
(Only for external wastegate type)



- (6) Display the Warning Point



- 3 After the program goes though each display once, the display returns to the active boost gauge display.

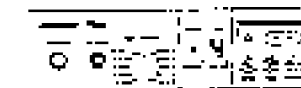

4. If a change is made to any of the setting while the vehicle is OFF (not running), upon restarting, an alarm will sound and a 'CH' (Check Setting Light) will be flashing in the LED display screen. This indicates that a change has been made to the Profec's settings while the vehicle was OFF. By pressing the Power switch once the setting that was altered will show in the display screen. By pressing the Power switch a second time this setting will be accepted by the Profec.

PROFEC TROUBLE SHOOTING

PROBLEM	SOLUTION
<ul style="list-style-type: none"> • Cannot Turn the Power On 	<ul style="list-style-type: none"> • Harness not connected correctly check connection. • Check the Power Source
<ul style="list-style-type: none"> • Cannot Turn the Power Off 	<ul style="list-style-type: none"> • In "P-1" and "P-2" mode, you cannot turn the Power OFF.
<ul style="list-style-type: none"> • Over boost in "P-1" mode 	<ul style="list-style-type: none"> • Check Dip switch setting on rear of unit • Check filter for damage. • Possibility of the Stepping Motor exposed to excessive heat. Remount the motor to a cooler location in the engine room. (Ex by air filter box) • Recheck all the vacuum hose connections.
<ul style="list-style-type: none"> • Difficult to learn "P-2" 	<ul style="list-style-type: none"> • Bad Ground. If the Black wire is grounded to the body, make sure the paint on body is filed off, or connect it straight to the negative side of battery. • Re-run "P-1" and set the Set Boost 0.1 kg/cm less than the stock boost pressure or try Alternative Learning Procedure. • Making the test runs at half throttle. Make sure the test run is done at full throttle • The gear the test runs are being performed does not reach the stock maximum boost pressure. Change to a higher gear and do the run over.
<ul style="list-style-type: none"> • After the Learning procedure the boost is not stable. 	<ul style="list-style-type: none"> • The Profec has not completely learned the turbo's boost curve. Make few more runs until the boost gets stable • Check the ground wire. • Check the filter on the Stepping Motor for cracks or defects. • Check the vacuum hose routing for the Profec.
<ul style="list-style-type: none"> • The boost falls off to stock boost 	<ul style="list-style-type: none"> • Check the charge pipes and hose connections. • Check the Blow Off Valve • The Set Boost setting is set higher than the Warning setting • Check the filter on the Stepping Motor for cracks or defects. • Check the vacuum hose routing for the Profec
<ul style="list-style-type: none"> • Over boosting Problem 	<ul style="list-style-type: none"> • Check the Dip switch setting on rear of unit. • The wastegate capacity too small, up grade your wastegate. • Check the vacuum hose routing. • Check the filter on the Stepping Motor for cracks or defects.

Profec Trouble Shooting

PROBLEM	SOLUTION
• Not able to go to O.T.B. mode	• The O.T.B. Operation Time setting is Set to "0". Set the Time above "0".
• The indicator display shows "-1" and does not move.	• The wire harness no connected correctly.
• Stepping Motor is making a clicking noise.	• It is normal. The motor is active at all times, whether the Profec is ON, or OFF